



# Optical Switches: Making Optical Networks a Brilliant Reality

## Definition

With their improved efficiency and lower costs, optical switches provide the key for carriers to both manage the new capacity dense wavelength division multiplexing (DWDM) provides as well as gain a competitive advantage in the recruitment and retention of new customers. However, with two types of optical switches being offered, there is a debate over which type of switch to deploy—intelligent, optical-electrical-optical (O-E-O) switches, or all-optical, optical-optical-optical (O-O-O) switches. The real answer is that both switches offer distinct advantages, and, by understanding where and when deployment makes sense, carriers can optimize their network and service offerings.

## Overview

Carriers have embraced DWDM as a mechanism to quickly respond to an increasing need for bandwidth, particularly in the long-haul core network. Many of these carriers have also recognized that this wavelength-based infrastructure creates the foundation for the new-generation optical network. However, as DWDM delivers only raw capacity, carriers now need to implement a solution to manage the bandwidth that DWDM provides. Optical switches present the key for carriers to manage the new capacity and gain a competitive advantage in the recruitment and retention of new customers. To secure improved efficiency, lower cost, and new revenue-generating services, carriers have two choices of optical switches to control their bandwidth and rising capital expenses, the O-E-O switch and the all-optical, photonic-based O-O-O switch. A logical evolution path to the next-generation network must include the deployment of intelligent O-E-O switches to ensure that current needs are met and that all-optical O-O-O switches are added where and when they make sense. Therefore, there is no debate on whether carriers need to deploy either O-E-O or O-O-O, but there is on how to optimize network and service offerings through the implementation of both switch types.

# Topics

Definition and Overview

1. The Evolving Core Optical Networks
2. Economical Challenges
3. Two Types of Optical Switches
4. All-Optical Switches
5. Intelligent O-E-O Switches
6. Space and Power Savings
7. Optimized Optical Nodes

Self-Test

Correct Answers

Glossary

## 1. The Evolving Core Optical Network

Carriers have embraced DWDM as a mechanism to quickly respond to an increasing need for bandwidth, particularly in the long-haul core network. Many of these carriers have also recognized that this wavelength-based infrastructure creates the foundation for the new-generation optical network. This new-generation network must fulfill the demands of the new information age, which requires improved scalability, flexibility, and dynamic delivery of communication services. An evolution of the network is underway to meet this demand. The evolution introduces new network elements supporting an architecture that is better suited for the dynamic global distribution of broadband-based services. The next major step in this progression is the wide-scale deployment of intelligent core optical switches.

Figure 1. Optical Network Elements

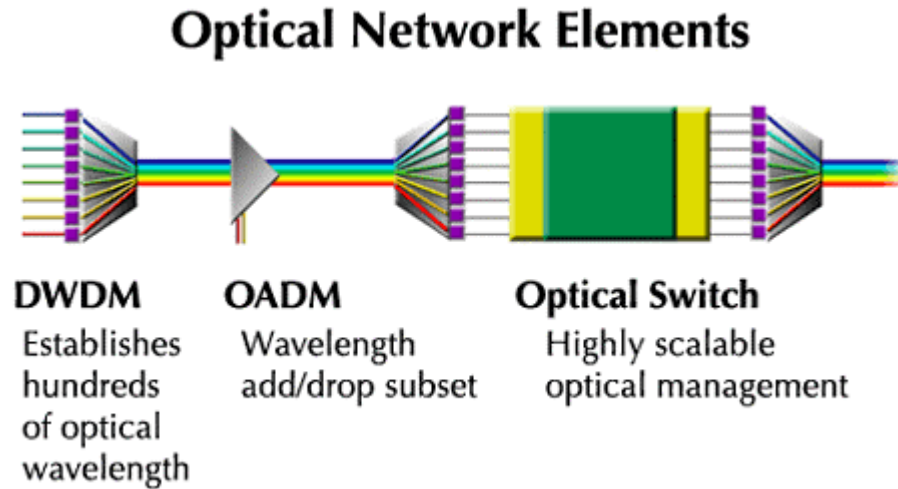

Intelligent core optical switches converge the functions of transport, high bandwidth cross-connects and improved data-centric communication to more efficiently distribute a wide range of data types across a core network. These new network elements are designed to better accommodate the unique demands of data while also supporting other services such as voice and video. Carriers are evolving their networks to support new bandwidth and new wavelength-based services.

The new services will support the global distribution of new broadband applications such as medical imaging, Internet movies, interactive customer support, and additional applications that have yet to be discovered.

## 2. Economical Challenges

In addition, recent economical challenges have highlighted the fact that the network evolution must increase the efficiency and manageability of a network, resulting in lower equipment and operational costs. A growing number of carriers have accepted the evolutionary benefits of the optical switch. Carriers must decide how best to implement the optical switch to gain a competitive advantage in the recruitment and retention of new customers. Promises of improved efficiency, lower cost, and new revenue-generating services are being made by manufacturers of two types of optical switches—the O-E-O switch and the all-optical, photonic-based O-O-O switch.

Figure 2. Two Types of Optical Switches

## Two Types of Optical Switches

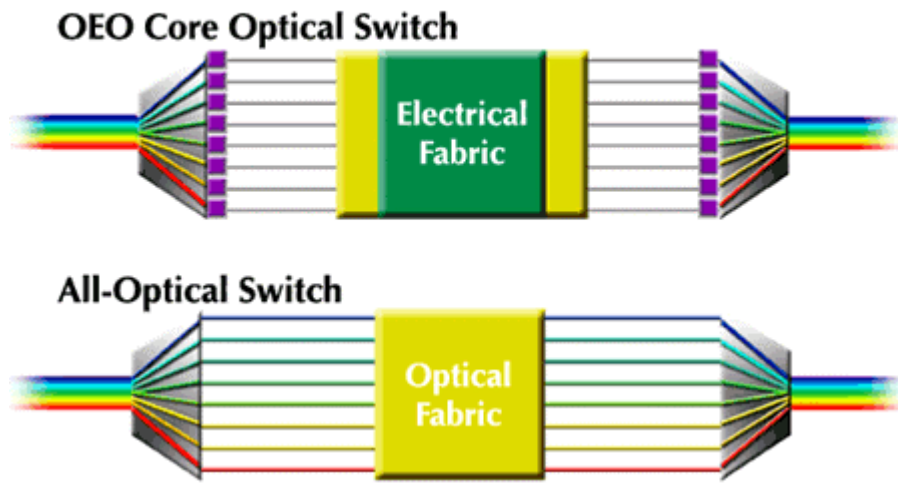

### 3. Two Types of Optical Switches

As carriers weigh their options, many have contemplated a network evolution consisting of intelligent O-E-O switches. Others have dreams of even greater cost savings by eliminating electronic components, resulting in an all-optical O-O-O switch. These new-generation O-O-O switches are viewed as an integral component of an all-optical network (AON).

A theoretical AON is transported, switched, and managed totally at the optical level. The goal is that an AON is faster and less expensive than an optical network using electronic parts. As we have learned so many times before, theory does not always provide the expected results when exposed to the reality of the real world. In fact, the O-O-O switch and the intelligent O-E-O switch each have their place in the network. Carriers, looking to gain a competitive advantage would be wise to evolve their networks to maximize the benefits of both switches.

So, the debate of O-O-O versus O-E-O has evolved into the question of how the two will interoperate. The true promise of optical networking, including improved flexibility, manageability, scalability and the dynamic delivery of new revenue-generating services is best accomplished through the optimized deployment of intelligent O-E-O switches combined with the appropriate future integration of O-O-O switches.

## 4. All-Optical Switches

All-optical switches are made possible by a number of technologies that allow the managing and switching photonic signals without converting them into electronic signals. Only a couple of technologies appear ready to make the transition from the laboratory to the network, where they must support the basic feature set of a carrier-grade, scalable optical switches. Arguably, the leading technology for developing an economically viable, scalable all-optical, O-O-O switch is the 3D micro-electromechanical system (MEMS). 3D MEMS uses control mechanisms to tilt mirrors in multiple direction (3 dimensional).

Figure 3. Optical-Switch Technologies  
**OXC Switch Architectures:  
 All-Optical Fabrics**

	<i>Free-space</i>		<i>Guided Wave</i>	
	<i>MEMS</i>	<i>Liquid Crystal</i>	<i>Thermo-Optic Bubble</i>	<i>Thermo-Optic/ Electro-optic Waveguide</i>
Scalability	√	<b>X</b>	<b>X</b>	<b>X</b>
Loss	√	?	<b>X</b>	?
Switching time	√	?	?	√
Cross-talk	√	?	?	?
Polarization Effects	√	? √	? √	<b>X</b>
Wavelength Independence	√	√	√	<b>X</b>
Bit-rate Independence	√	√	√	√
Power Consumption	√	√	<b>X</b>	<b>X</b>
	√ good		? unsure	<b>X</b> bad

An optical switch adds manageability to a DWDM node that could potentially grow to hundreds of channels. An O-O-O switch holds the promise of managing those light signals without converting the signals to electrical and then back again. This is especially attractive to those carriers operating large offices where up to 80% of the traffic is expected to pass through the office on its way to locations around the globe. MEMS currently affords the best chance of providing an all-optical switch matrix that can scale to the size needed to support a global communications network node with multiple fibers, each carrying hundreds of wavelengths.

Figure 4. 3D MEMS

## 3D-MEMS: Analog Gimbal-Mirror Switch

### Complementary features

- Virtues
  - Scales beyond 1000 x 1000 in single stage
- Challenges
  - Large number of mirrors with tight tolerances
  - Control of Mirrors
- Require meticulous engineering
  - Mirror-control algorithm
  - Fiber arrays
  - Lens arrays
  - Mechanical packaging

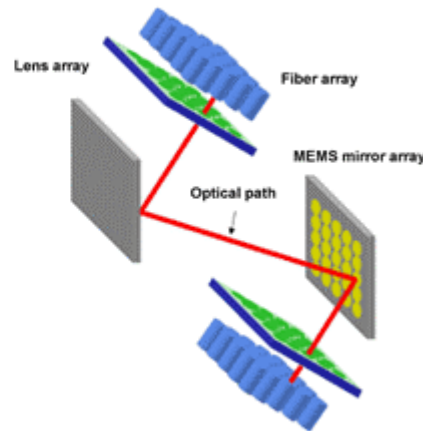

The increased level of control enabled by MEMS technology can direct light to a higher number of ports with minimal impact on insertion loss. This is the key to supporting thousands of ports with a single stage device. The 3D MEMS-based O-O-O switches will be introduced in sizes ranging from 256 x 256 to 1000 x 1000 bi-directional port machines. In addition, encouraging research seems to show that 8000 x 8000 ports will be practical within the foreseeable future. The port count, however, is only one dimension to the scalability of an O-O-O switch. An O-O-O switch is also scalable in terms of throughput. A truly all-optical switch is bit-rate and protocol independent. The combination of thousands of ports and bit-rate independence results in a theoretically future-proof switch with unlimited scalability.

Some argue that a bit-rate and protocol independent switch encourages rapid deployment of new technologies such as 40 gigabits per second (Gbps) transport equipment. After all, a carrier does not have to worry about shortening the life span of an O-O-O switch by implementing new technology as subtending equipment.

In addition to aiding the scalability of an O-O-O switch, a bit-rate and protocol-independent switch theoretically improves the flexibility of a network. Flexibility can be improved because a carrier can offer a wavelength service and empower its customer to change the bit rate of the wavelength "at will" and without carrier intervention. While this type of service is already being offered in its simplest form—wavelength leasing—it has the future value of supporting optical virtual private networks (O-VPN) and managed- or shared-protection wavelength services.

In theory, a future-proof, scalable, flexible and manageable O-O-O switch meets the requirements for a new-generation optical switch. In the real world, however, a carrier must evaluate the pros and the cons of all possible options and then select the most economically viable solution.

## All-Optical Challenges

While the benefits of O-O-O switches are clear, carriers must understand and consider the challenges/implications that may limit the adoption of all-optical switches in a long-haul core optical network. These challenges have hindered mass production of all-optical switches and limited deployment to less than a handful. A more in-depth look at some of these challenges will show why some experts don't expect wide-scale deployment of all-optical switches for several years.

## Optical Fabric Insertion Loss

Optical switching fabrics can have losses ranging from 6 to 15 decibels (dB), depending on the size of the fabric, the switching architecture (single stage versus multi-stage), and the technology used to implement the switching function. A multi-stage fabric compounds the insertion loss challenge, because additional loss is encountered each time the stages are coupled together. The 3D MEMS-based switches can be implemented in a single-stage architecture to minimize insertion loss. However, even at the low end—6 dB—a carrier must be aware of the output level of the devices interfacing with the all-optical switch. Subtended equipment, such as DWDM or data routers, must have enough power to ensure that a signal is able to transverse an optical switch matrix. This could lead to the need for higher-power lasers on these devices, thereby increasing the cost burden of the surrounding equipment.

## Network-Level Challenges of the All-Optical Switch

The problem of loss is compounded when an O-O-O switch is implemented in an all-optical network. An all-optical network is defined as one that does not use O-E-O conversion in the path of the traffic-bearing signal. Thus, a system consisting of DWDM and all-optical switches will not use transponders or 3R regenerators to mitigate the affects of optical impairments. Optical budget is only one of the considerations, which must be studied carefully before implementing an all-optical switch.

Figure 5. All-Optical Switch

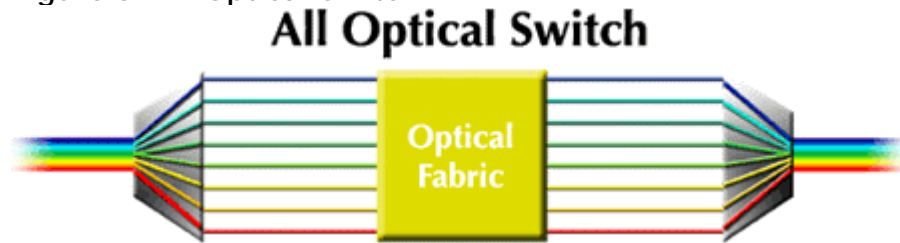

Prior to implementation, carriers must consider the many implications of an O-O switch, including physical impairments such as chromatic dispersion, polarization mode dispersion, non-linearities, polarization dependent degradations, wavelength division multiplexing (WDM) filter passband narrowing, component crosstalk, and amplifier noise accumulation.

As stated earlier, the next-generation network must not only be scaleable and flexible, but it also must be dynamic. A dynamic network will generally consist of optical switches deployed in a mesh architecture to support a flexible number of services, restoration paths, and fast point-and-click provisioning. A dynamic network with multiple restoration paths is not conducive to end-to-end optical-path engineering. It is just not practical at this time to engineer an all-optical system to handle all the possible network degradations for all possible provisioning or restoration paths.

In addition to mitigating the effects of physical impairments, carriers require multivendor interoperability and wavelength conversion. They are also unwilling to compromise on network-management functions that are available to them today. These include the following:

- a. Automatic topology discovery
- b. SONET–keep-alive generation
- c. Performance monitoring
- d. Connection verification
- e. Intra-office fault localization
- f. Bridging



## 5. Intelligent O-E-O Switches

Network-management functions, which are an important part of operating a network, are available today using an optical switch having an electronic-based switching matrix. Available today with proven technology, these intelligent O-E-O switches address the need for high-bandwidth management while continuing the tradition of providing easy fault location and the performance-monitoring information necessary to monitor and report on the health of a network. The intelligent O-E-O switch using an electronic fabric is also able to offer bandwidth grooming, which is not available in an all-optical switch. Although an O-O-O switch will support a new class of wavelength-based services, the intelligent O-E-O switch will support a new class of high-bandwidth services. This is an incremental step in the operations and maintenance of a new service class that is not disruptive to a carriers' normal mode of operations. It addresses the need to manage a larger aggregate of bandwidth by processing and grooming the information at a 2.5 Gbps rate. By using an electronic-based fabric, the intelligent O-E-O switch is able to overcome the network impairments that currently limit the use of an all-optical switch in a dynamic mesh architecture. An intelligent O-E-O switch combines the latest generation hardware with sophisticated software to better accommodate the data-centric requirements of a dynamic optical network. The intrinsic 3R regeneration functions allow the intelligent optical switch to be deployed in various network architectures including mesh. An intelligent O-E-O switch provides carriers with a marketable service differentiator against their competition by offering carrier-grade protection and fast provisioning of services.

Figure 6. O-E-O Switch

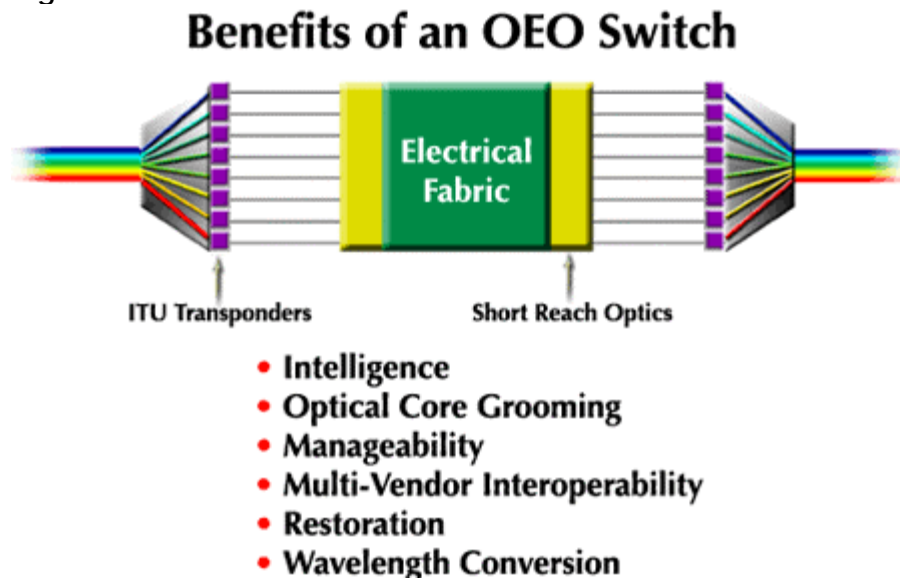

The intelligent O-E-O switch encourages the use of mesh, which is more bandwidth efficient and supports a flexible set of bandwidth-intensive service offerings. The electronics used in an intelligent optical switch also allows it to make use of the well-accepted synchronous optical network (SONET) standards. This not only helps with network management, but it also encourages the use of best-of breed network elements by furthering interoperability among devices from multiple vendors. Not only does the intelligent O-E-O switch offer advantages from the reuse of SONET standards, but it also includes an evolution path to maximize the use of a set of data standards to improve data-centric communications and make the network more dynamic while greatly reducing provisioning times. The evolution of the intelligent optical switch includes the support of evolving standards such as optical-user interface network (O-UNI)/generalized multiprotocol label switching (GMPLS). GMPLS is an emerging standard, which is based on the established, data-oriented, multiprotocol label switching (MPLS) standard. MPLS is a standard suite of commercially available data protocols that handles routing in a data network.

Figure 7. O-UNI Using Intelligent Optical Switches

## O- UNI Overlay Using Intelligent Optical Switches

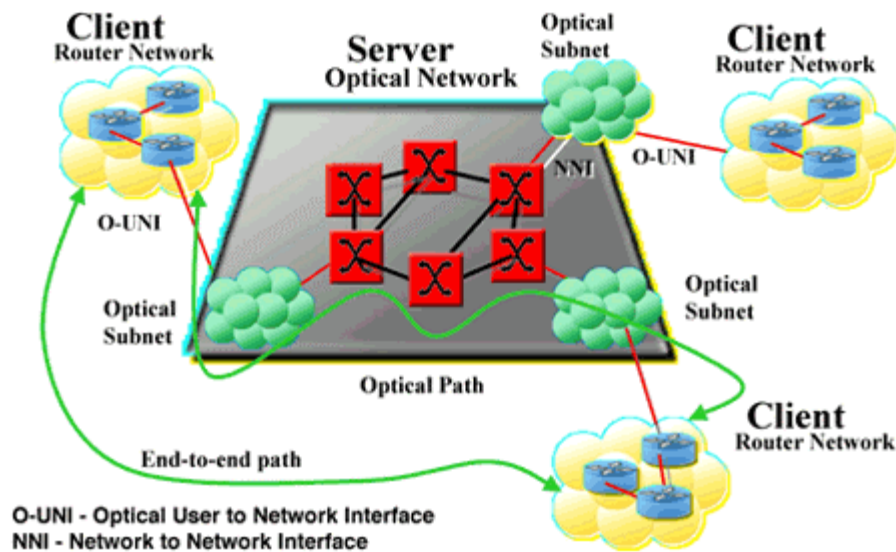

GMPLS is intended to make the benefits of data routing available to large carrier-class optical switches supporting dynamic global networks. Intelligent optical switches are currently being deployed in networks. They are helping to evolve the network while also providing carriers with both cost-reduction and new revenue-generating services. The intelligent optical switches, using an electronic-based switching fabric, mitigate the risks that are associated with the deployment of new all-optical technology. O-E-O switches are available today and can be deployed without the technical challenges of all-optical switches. As these

switches continue to scale, support new data-centric features, and drop in price, they diminish the need for all-optical switching.

## OxO

The intelligent O-E-O switch currently provides an evolution path for the next-generation network without the network risks imposed by all-optical O-O-O switches. This is not to say that the all-optical switch will not or should not be deployed in the next-generation network. On the contrary, the all-optical switch should be added to the network at the right time to continue the evolution to a less costly, more manageable dynamic network. However, instead of viewing the all-optical switching technology as competition to an electronic-based optical switch, we must embrace the idea that the two are complementary, allowing a best of both: OxO. Carriers can use a combination of the two switches to offer new bandwidth and end-to-end wavelength services. The O-E-O switch will help mitigate the network impairments, which would otherwise accumulate with all optical switches. And, the all-optical switch will help to further the trend of reducing the footprint and power requirements in an office while providing bit-rate and protocol transparency for new revenue service offerings.

Figure 8. Best of OxO

### OXC Arch: Best of Both

Function	Transparent 'All-Optical' Switch	Electronic Switch	Best of O&E
Performance-monitoring	Complex	Simple	Simple
Connection-verification	Complex	Simple	Simple
Fault-isolation	Complex	Simple	Simple
Automatic Topology-discovery	Complex	Simple	Simple
Graceful scaling in line rate	Yes	No	Yes
Multicast	No	Yes	Yes
Subrate grooming	No	Yes	Yes
Unconstrained restoration algorithm?	No	Yes	Yes
In-band signaling	No	Yes	Yes

## 6. Space and Power Savings

As technology improvements allow greater bundles of fiber to terminate in an office and DWDM builds a foundation of hundreds of wavelengths per fibers, carriers are challenged with finding the space and power for the necessary communications equipment. In the current mode of operation, most optical signals are converted to lower-level electrical signals. The signals are generally groomed and cross-connected before being converted back into an optical signal for transport. These functions require hundreds of electronic chips, and these chips require space and power. Each process, grooming and cross-connects, requires a minimum set of functionalities. In the past these separate elements were designed to optimize each function. Grooming involved demuxing signals into lower bit rates and then repackaging the signals to more efficiently transport them to their next destination. Cross-connects were used to more efficiently manage signals between transport equipment. With the amount of optical signals that can now terminate in an office, carriers would either require very tall high rises or need city blocks just to hold all the transport and cross-connect equipment.

If a carrier overcomes the real-estate challenge, it is faced with the daunting task of supplying power for all of this equipment.

Figure 9. Space and Power Savings

### **Carrier OEO Economics**

- 60 – 70% lower capital cost
- 50 – 70% less power
- 90% less space
- Provisioning in minutes, not months
- New revenue opportunities
- Lower operating costs



All-optical O-O-O switches hold the promise of significantly reducing both the footprint and power consumption required in a communications office. All-optical switches supporting 1000 x 1000 ports will be available in a space of two to four bays of equipment.

Each bay will require one kilowatt (kW) or less of power for a total of two to four kW. This compares to SONET-based digital cross-connects ranging in size from 25 to 32 bays of equipment. Each electronic cross-connect bay requires four to five kW for a total of 100 to 128 kW of power. The all-optical switch can therefore provide a 92 percent reduction in floor space requirements and a 96 percent reduction in power requirements.

The power savings result in cost savings at multiple levels. First of all, each rack will save about three kW each of power. This translates into a footprint and cost savings for power-generating and distribution equipment such as batteries, rectifiers, and diesel generators. Each of those units must be maintained, requiring monthly test routines and periodic burn-off of diesel fuel. Thus, there is also an operations and maintenance savings. Lastly, the carrier must purchase and maintain air-conditioning units capable of cooling their offices. The lower the heat dissipation, the lower the monthly cooling charges. These are operational costs that are not only tangible, but also significant.

## 7. Optimized Optical Nodes

A logical evolution path to the next-generation network must include the deployment of intelligent O-E-O switches to ensure that current needs are met as well as the addition of all-optical O-O-O switches when and where they make sense. Carriers are currently deploying intelligent O-E-O switches that offer space and power savings over traditional network architectures such as stacked SONET rings and digital cross-connects. These intelligent optical switches continue to benefit from technical advances and the cost reduction of electronic chip devices. They provide carriers the opportunity to implement new data-oriented services now and into the future. As all-optical switching technology matures, carriers need not worry about replacing their intelligent optical switches. Instead, carriers must optimize their network and service offering through the implementation of both switch types. A carrier whose primary service offering is bandwidth-based must maintain an intelligent O-E-O optical switch that is capable of multiplexing and demultiplexing the different traffic. Carriers, who have the infrastructure and operational processes to support wavelength-based services are candidates for early implementation of all-optical switches. Together the two switch types provide scalability, manageability, and flexibility without introducing new network-management challenges into the network.

Figure 10. O-E-O and O-O-O Optical Nodes

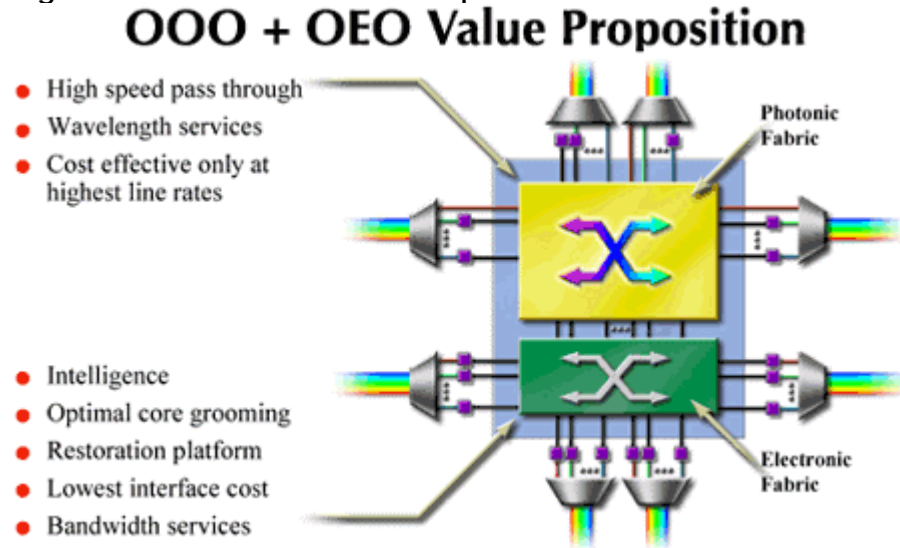

Most carrier services are currently bandwidth-based but will evolve to support more wavelength-based services, including optical virtual private networks and end-to-end wavelength services, where the end user has the power to change the bit rate at will. The increased rate of deployment of intelligent O-E-O switches is driving the emergence of next-generation optical networks. The addition of an all-optical O-O-O switch holds the promise of making this network even more flexible and manageable. Together the intelligent O-E-O switch and the all-optical O-O-O switch ensure a scalable next-generation network that can accommodate the dynamic nature of bandwidth-intensive broadband services.

# Self-Test

1. Optical switches promise to offer carriers which of the following benefits?

- a. Improved efficiency
- b. Lower capital expenditures (CAPEX) and operational expenditures (OPEX)
- c. New revenue-generating services
- d. All of the above

2. Utilizing O-E-O switches in the core of the network can provide which of the following?

- a. 60-70 percent lower capital cost
- b. 50-70 percent less power
- c. 90 percent less space
- d. All of the above

3. Which of the following technologies is arguably the leading technology for enabling an economically viable, scalable, all-optical, O-O-O switch?

- a. Liquid crystal
- b. Thermo-optic bubble
- c. MEMS
- d. Thermo-optic/Electro-optic waveguide

4. Which of the following is a key strength of an all-optical, O-O-O switch?

- a. Wavelength conversion
- b. Optical core grooming
- c. Restoration

- d. Protocol and rate independence
5. Which of the following is a key strength of intelligent O-E-O switches?
- a. Manageability
  - b. Intelligence
  - c. SONET-like protection and restoration
  - d. All of the above
6. Rapidly increasing bandwidth demand is making carriers demand which of the following capabilities in their networks?
- a. Improved scalability
  - b. Ability to quickly bring new bandwidth on-line
  - c. Increased manageability and efficiency
  - d. All of the above
7. The grooming requirements of carriers will be met by O-O-O switches.
- a. true
  - b. false
8. A future optimized optical node will use all-optical O-O-O switching for pass through traffic while O-E-O switching will be used for service provisioning, demuxing signals into lower bit rates and repackaging them for more efficient transport.
- a. true
  - b. false
9. With two types of optical switches being offered, which of the following is true?
- a. The current core network will receive the most benefit from using O-E-O switches exclusively.
  - b. The current core network will receive the most benefit from using O-O-O switches exclusively.



- c. As technology develops the two types of switches will coexist and complement each other.
- d. None of the above

10. Carriers can derive immediate economic benefit from CAPEX and OPEX savings in addition to gaining ongoing top-line revenue from the implementation of optical switches

- a. true
- b. false

## Correct Answers

1. Optical switches promise to offer carriers which of the following benefits?

- a. Improved efficiency
- b. Lower capital expenditures (CAPEX) and operational expenditures (OPEX)
- c. New revenue-generating services
- d. All of the above**

2. Utilizing O-E-O switches in the core of the network can provide which of the following?

- a. 60-70 percent lower capital cost
- b. 50-70 percent less power
- c. 90 percent less space
- d. All of the above**

3. Which of the following technologies is arguably the leading technology for enabling an economically viable, scalable, all-optical, O-O-O switch?

- a. Liquid crystal
- b. Thermo-optic bubble
- c. MEMS**
- d. Thermo-optic/Electro-optic waveguide

4. Which of the following is a key strength of an all-optical, O-O-O switch?
- a. Wavelength conversion
  - b. Optical core grooming
  - c. Restoration
  - d. Protocol and rate independence**
5. Which of the following is a key strength of intelligent O-E-O switches?
- a. Manageability
  - b. Intelligence
  - c. SONET-like protection and restoration
  - d. All of the above**
6. Rapidly increasing bandwidth demand is making carriers demand which of the following capabilities in their networks?
- a. Improved scalability
  - b. Ability to quickly bring new bandwidth on-line
  - c. Increased manageability and efficiency
  - d. All of the above**
7. The grooming requirements of carriers will be met by O-O-O switches.
- a. true
  - b. false**
8. A future optimized optical node will use all-optical O-O-O switching for pass through traffic while O-E-O switching will be used for service provisioning, demuxing signals into lower bit rates and repackaging them for more efficient transport.
- a. true**
  - b. false

9. With two types of optical switches being offered, which of the following is true?

- a. The current core network will receive the most benefit from using O-E-O switches exclusively.
- b. The current core network will receive the most benefit from using O-O-O switches exclusively.
- c. As technology develops the two types of switches will coexist and complement each other.**
- d. None of the above

10. Carriers can derive immediate economic benefit from CAPEX and OPEX savings in addition to gaining ongoing top-line revenue from the implementation of optical switches

- a. true**
- b. false

# Glossary

**AON**

All Optical Network

**DWDM**

Dense Wavelength Division Multiplexing

**GMPLS**

Generalized Multiprotocol Label Switching

**MEMS**

Micro-Electromechanical Systems

**MPLS**

Multiprotocol Label Switching

**O-E-O**

Optical-Electrical-Optical

**O-O-O**

Optical-Optical-Optical

**O—UNI**

Optical-User Network Interface

**O—VPN**

Optical-Virtual Private Network

**SONET**

Synchronous Optical Network